



1700-16-16

MJ-FLANGE Straight Code 61

<http://brennaninc.com/buy/1700-16-16>

BRENNAN INDUSTRIES, EXTRAORDINARY FITTINGS

In business for over 60 years, Brennan supplies more than 40,000 types of hydraulic fittings and adapters in sizes ranging from 1/16 to 3 inches. This wide range of fittings includes tube, O-ring face seal, instrumentation, metric bite type, push-to-connect, conversion and flareless bite type, as well as valves, clamps and swivels. Brennan products are stocked at strategically located, full-service distribution centers in: Atlanta, Cleveland, Dallas, Houston, Los Angeles, Seattle, Birmingham UK, Toronto and Shanghai.

Visit us at brennaninc.com or give us a call at 800.331.1523

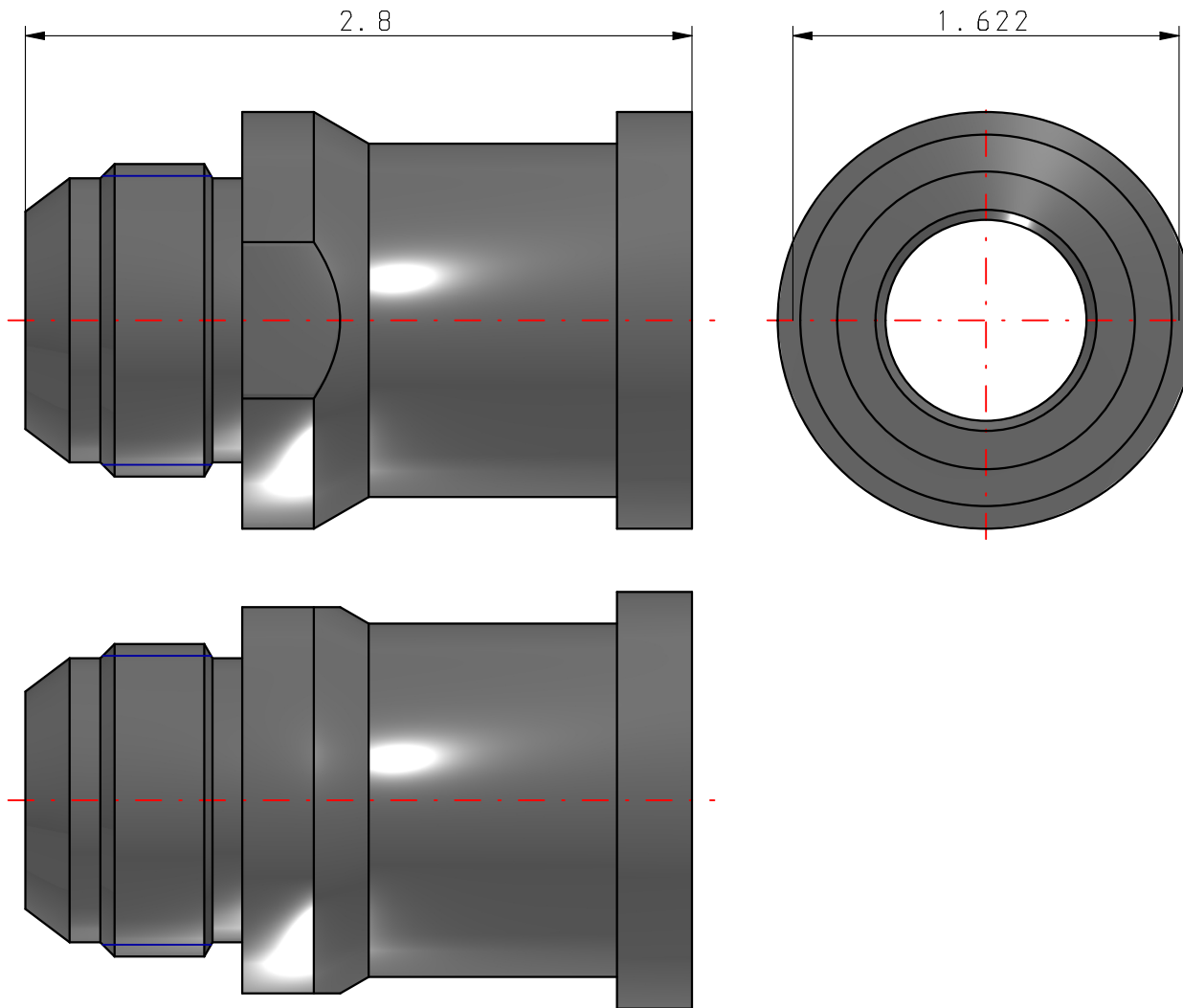
**Product Selection and Safety**

The complete Brennan electronic and printed catalog materials' content must be reviewed to ensure that the system designer and user make a safe product selection. When selecting products, the total system design must be considered to ensure safe, troublefree performance. Function, material compatibility, adequate ratings, proper installation, operation, and maintenance are the responsibilities of Brennan's customer, the system designer, installer, contractor and user. CAD Models, drawings and literature are provided "as-is" without any representation or warranty or fitness for any particular purpose and are for reference only.

1700-16-16